

A

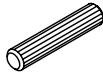

B



C

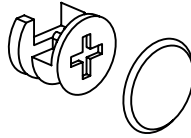

D

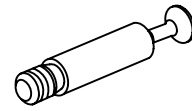

E



F

RP : Right Panel

LP : Left Panel

BP : Back Panel

DP : Desk Panel

1

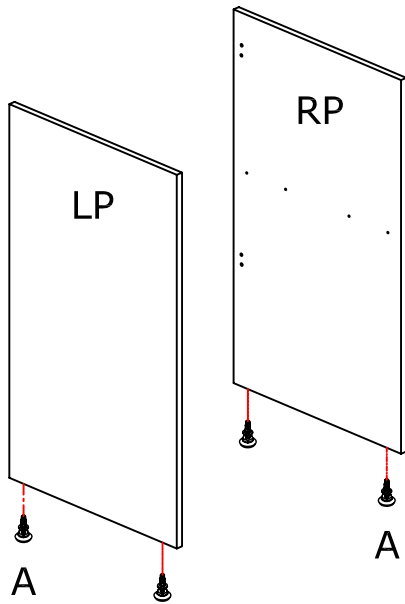

2

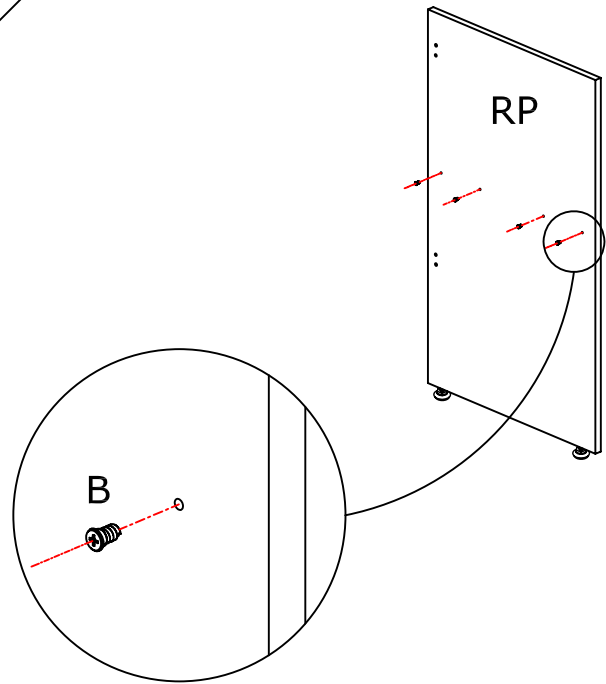

3

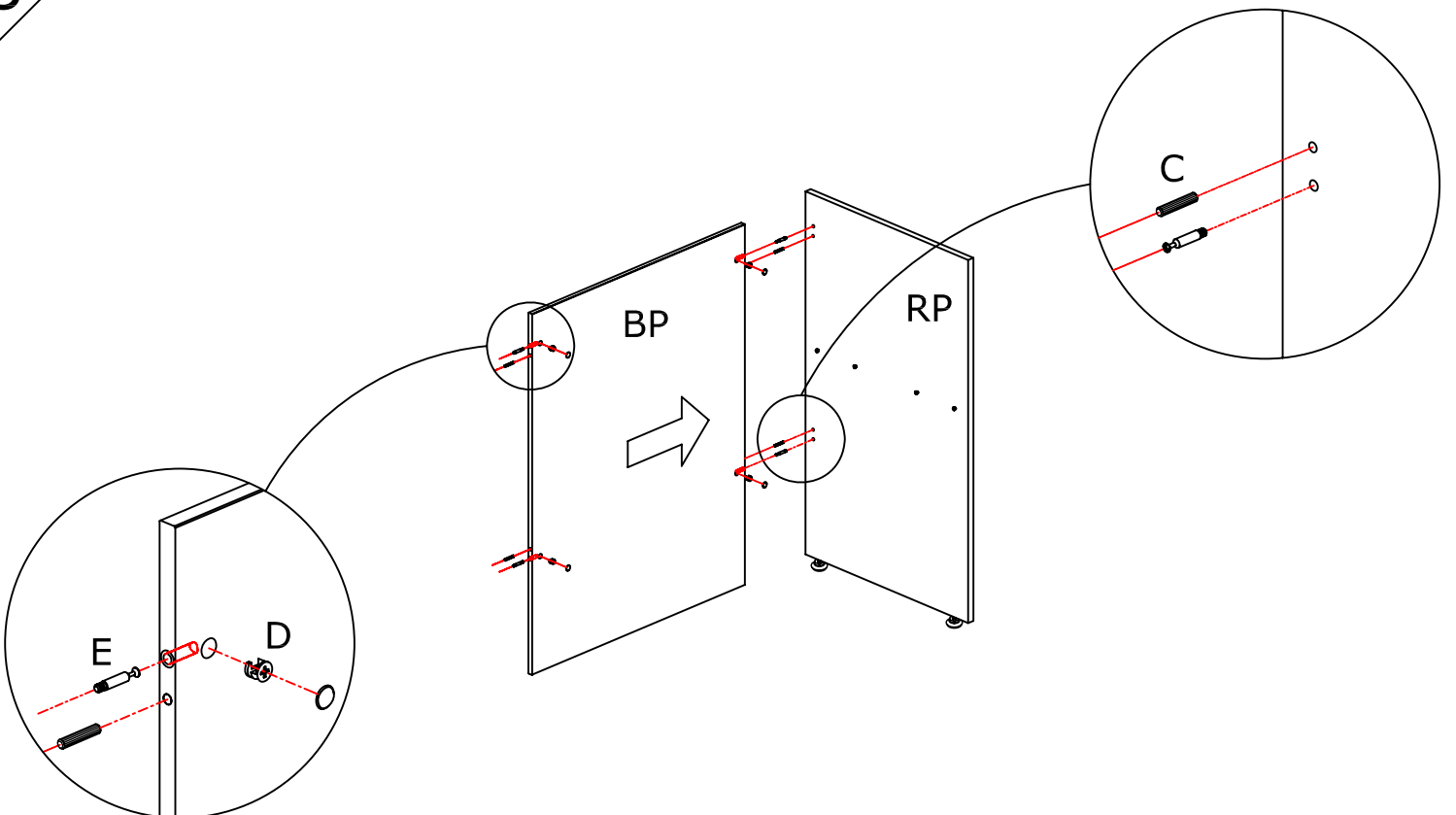

4

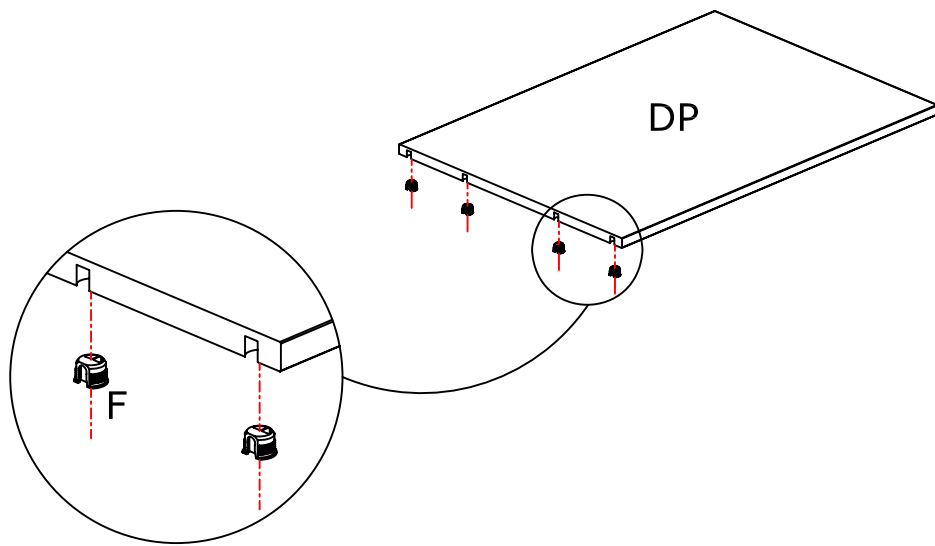

5

